

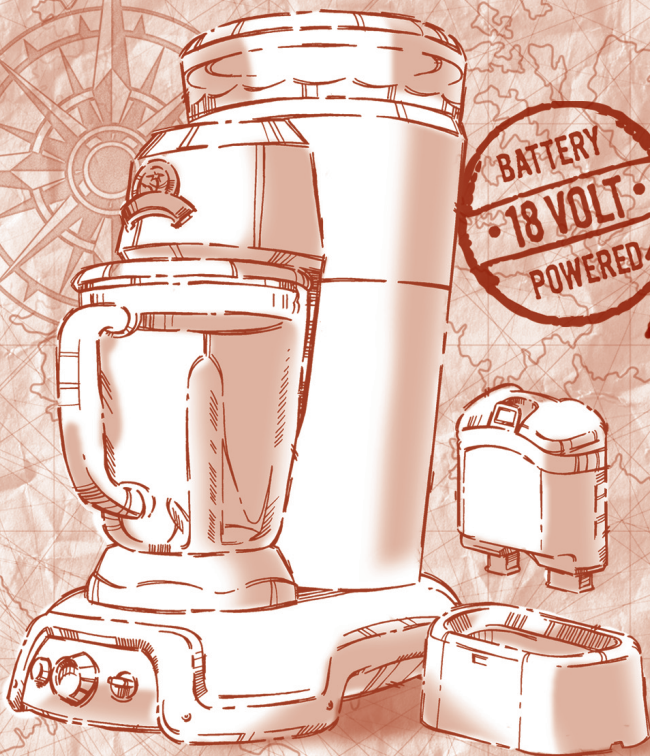

CORDLESS FROZEN CONCOCTION MAKER®

The Best Margaritas Come From Margaritaville®



Model NBMGDM0900 Series User Manual



WELCOME TO MARGARITAVILLE[®]

Here's a discovery as earth shattering as the New World the Margaritaville[®] Explorer[™] Battery Powered Frozen Concoction Maker[®]. With no need for a cord, this portable powerhouse will lead your party into uncharted territories. Take it tailgating. Throw a bash at the beach. Whip up frozen drinks right on your boat. Yes, this is Paradise Unplugged.

“NO SHOES, NO SHIRT, NO CORD, NO PROBLEM!”

The Explorer[™] instruction manual was developed to help quickly familiarize you with your Cordless Frozen Concoction Maker[®]. You're just a few short steps away from Margaritaville[®], enjoying a perfectly prepared frozen drink. To learn more or to purchase other Margaritaville[®] products, please visit us at

www.margaritavillecargo.com.



TABLE OF CONTENTS

<i>p.1</i>	Important Safeguards
<i>p.3,4</i>	Parts List
<i>p.4</i>	The Control Panel
<i>p.5</i>	Battery Charger Instructions
<i>p.7</i>	Making Frozen Drinks
<i>p.8</i>	Recipes
<i>p.9</i>	Starting the Automated Shave-n-Blend Cycle
<i>p.10</i>	Perfecting Your Frozen Concoction
<i>p.11</i>	Cleaning & Maintenance
<i>p.13</i>	Troubleshooting
<i>p.14</i>	Warranty Information



IMPORTANT SAFEGUARDS

WHEN USING ELECTRICAL APPLIANCES, BASIC SAFETY PRECAUTIONS SHOULD ALWAYS BE FOLLOWED, INCLUDING THE FOLLOWING:

- 1. READ ALL INSTRUCTIONS BEFORE USING.**
2. To protect against electric shock, do not immerse appliance, Charger or Battery in water or other liquids.
3. Close supervision is necessary when any appliance is used near children. This appliance should not be used by children.
4. Turn off appliance and remove battery when not in use, before putting on or taking off parts, and before cleaning.
5. Flashing light indicates ready to operate. Avoid any contact with blades or movable parts.
6. Do not operate any appliance with a damaged Batter, after the appliance malfunctions, or is dropped or damaged in any manner. Do not operate charger with a damaged cord. Do not operate charger if damaged in any manner.
7. Not intended for outdoor use.
8. Do not let Charger cord hang over the edge of a table or counter, be in contact with wet areas, or touch hot surfaces, including the stove.
9. Keep hands and utensils out of container while blending and/or ice shaving to reduce risk of severe injury to persons or damage to the unit. A rubber spatula may be used but must be used only when the appliance is not running, and the Battery is removed from the unit.
10. Blades are sharp; handle with caution. Sharp blades are located in the main Ice Reservoir as well as in the bottom of Blending Jar.
11. Always operate appliance with Jar Lid and Ice Reservoir Lid in place.
12. The use of attachments not recommended or sold by the manufacturer may cause fire, electric shock, or injury.
13. Do not use broken, chipped, or cracked Blending Jar or Ice Reservoir. Contact 1-877-689-2737 for customer service.

14. To reduce risk of injury to persons, never place Blending Blade Assembly on base without the Blending Jar properly attached.
15. Do not leave appliance unattended while it is operating.
16. To disengage power, turn control to off, then remove Battery from the unit.
17. Do not use appliance for other than intended use.
18. Never place fingers or other utensils into feed or discharge areas.
19. Check Ice Reservoir for presence of foreign objects before using.
20. Be certain the Jar Lid and Ice Reservoir Lid are securely locked in place before operating appliance.
21. Do not blend hot liquids.
22. Do not short the Battery by placing metal objects across the terminals.
23. The Charger should be unplugged from the outlet when not in use.
24. The Charger should be plugged directly into an electrical outlet. Do not use an extension cord.
25. Do not incinerate this appliance even if it is severely damaged. The batteries can explode in fire. Dispose batteries only as noted in users manual.

NOTE: NEVER SHAKE OR REMOVE BLENDER JAR DURING OPERATION AS JAR BLADE ASSEMBLY CAN GET DAMAGED.

SAVE THESE INSTRUCTIONS FOR HOUSEHOLD USE ONLY

Polarized Plug

The Charger for this appliance has a polarized plug (one blade is wider than the other). As a safety feature, this plug will fit in a polarized outlet only one way. If the plug does not fit fully into the outlet, reverse the plug. If it still does not fit, contact a qualified electrician. Do not attempt to defeat this safety feature.

CORDLESS FROZEN CONCOCTION MAKER®

PARTS LIST

- 1 Ice Reservoir Lid – Covers the Ice Reservoir.
- 2 Ice Reservoir – Holds the ice for making frozen drinks.
- 3 Shaving Paddle – Moves ice across the Shaving Blade.
- 4 Ice Hopper – Guides ice towards Shaving Blade.
- 5 Ice Shaving Blade with Deflector – Shaves ice.
- 6 Shaving Blade Assembly Nut – Holds Shaving Blade in place.
- 7 Ice Chute – Directs shaved ice from Ice Hopper into Blending Jar.
- 8 Blending Base – Holds Blending Jar securely in place.
- 9 Control Panel – Contains all necessary controls to operate your unit.
- 10 Charger – Charges the Battery.

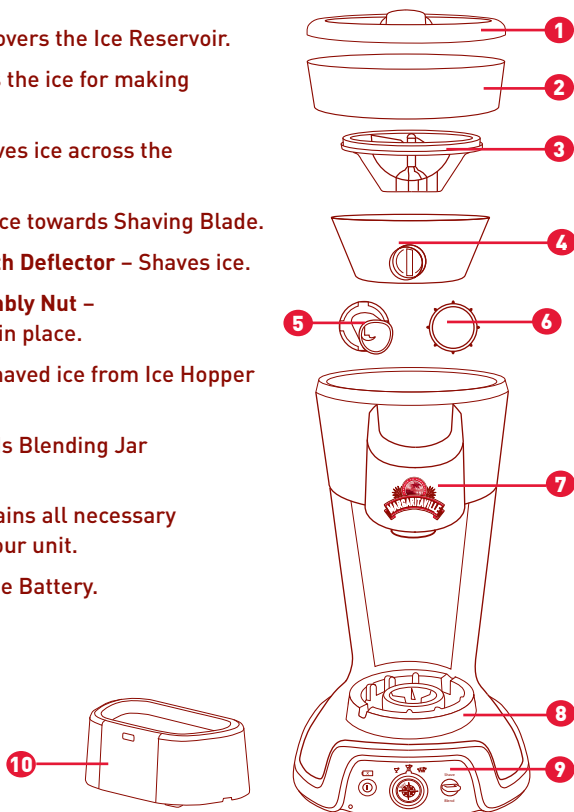

- 11 Jar Lid – Seals the blending jar.
- 12 Blending Jar – Maximum capacity of 36 oz (1 Liter).
- 13 Blending Blade Sealing Ring – Seals the Blending Jar and Blending Base.
- 14 Blending Blade – Mixes shaved ice with ingredients.
- 15 Jar Base – Designed with wide base for stability.
- 16 Ice Melt Reservoir – Captures melted ice excess.
- 17 18 Volt Battery Pack – Supplies power to the unit.

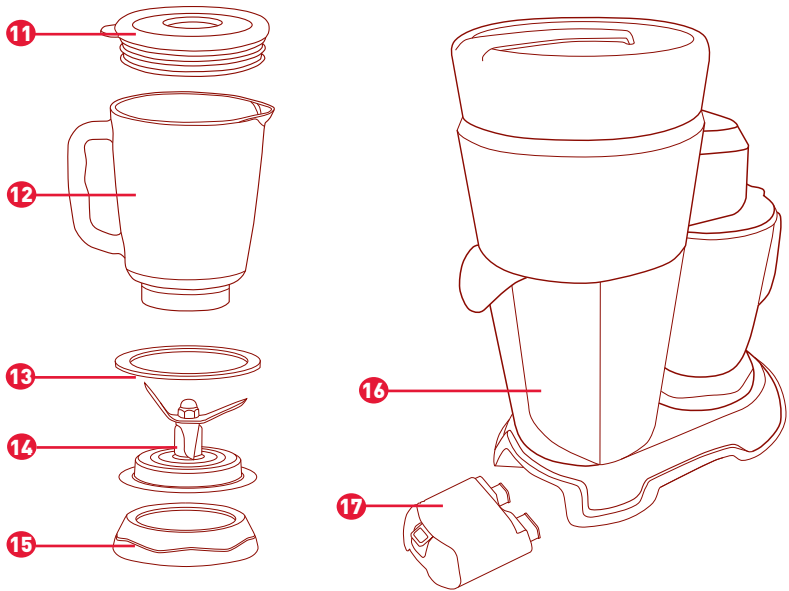

Control Panel

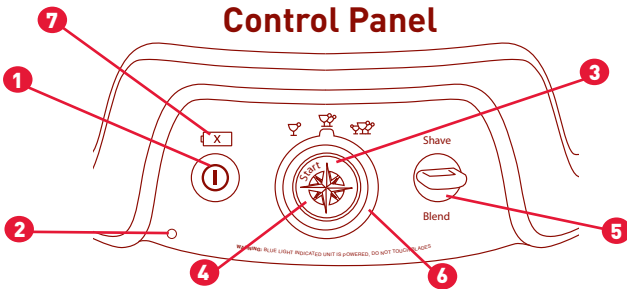

1 ON/OFF Button – Turns your unit on and off.

2 Power Indicator Light – Once the On / Off button is engaged, the power Indicator Light will blink slowly.

3 Shave 'n Blend™ Start Button – Used to start or interrupt the automatic Shave 'n Blend™ cycle.

4 Compass Indicator Light

- Solid blue = unit ready to operate.
- Pulsing blue = automatic cycle or manual mode engaged.

• Fast blinking red – fault mode (see troubleshooting section).

5 Manual Shave 'n Blend™ Toggle Switch – Used to manually operate ice shaver and blender.

6 Number of Drinks Rotary Switch – Used to select 1,2 or 3 Twelve oz. (355 mL) frozen drinks.

7. Low Battery Indicator Light - Illuminates when Battery needs to be charged.

Battery & Charger Instructions

To maintain optimum Battery and Charger performance, it is recommended that you follow these instructions.

How To Charge The Battery:

1. Remove the Battery & Charger unit from the Packaging and place it in a flat level surface.
2. Plug the power cord of the Charger into an 110V electrical outlet. A red status LED will illuminate.
3. Install the Battery by placing the end with the metal electrical terminals down into the Charger opening until it is fully seated. Upon installation, a red LED should pulse to signal charging status.

Note: If the red LED on the Charger blinks rapidly, a replacement Battery may be required. See troubleshooting section - pg. 13

4. When the Battery is fully charged in 4-6 hours, a green LED will illuminate to signal Battery is fully charged.
5. After the Battery is fully charged, remove it from the Charger.

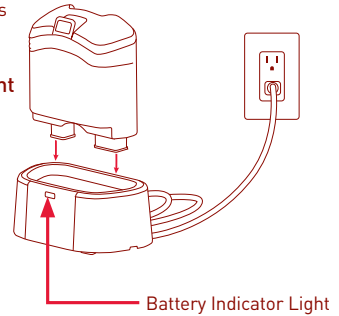

CHARGER INDICATOR LIGHT STATUS	
Light Signal	Status
Solid Red	Charger is receiving power
Pulsing Red	Battery is being charged
Solid Green	Battery is fully charged
Fast Blinking Red	Battery is in fault mode

Important Note: If left in the Charger for prolonged period, Battery damage can occur.

6. Unplug the power cord of Charger.

How Long To Charge The Battery:

After the Battery has been inserted into the Battery Charger the red LED light will pulse indicating that the Battery is being charged.

The Battery should be fully charged in 4-6 hours – and a green LED light will illuminate – signaling that the Battery is fully charged.

Warning: “READ ALL INSTRUCTIONS”

Failure to follow the SAFETY RULES identified below and other safety precautions may result in serious personal injury.

- Always turn off the appliance when the unit is not in use or remove the Battery Pack when the appliance will be stored away for more than 1 month.
- The Battery may leak under extreme usage or temperature conditions. If liquids come in contact with skin, quickly wash with soap and water, then with lemon or vinegar. If the liquid gets into the eyes, flush them with water for a minimum of 10 minutes and seek medical attention right away.
- Never operate the appliance in a moving vehicle or boat because serious injuries can result.
- Do not place batteries into fire or expose them to high heat. They may explode.
- When batteries are not in the appliance or Charger, keep them away from metal objects as they may short terminals.
- If the Battery case is cracked or otherwise damaged, do not insert into the Charger or Appliance.
- Do not charge Battery in a damp or wet environment.
- Only charge Battery Pack in temperatures above +40° F (4° C) and below +94° F (34° C) to do otherwise may damage the batteries.

Helpful Battery & Charger Information:

1. Only use the Battery provided by the manufacturer to operate this appliance.
2. Only use the Battery Charger provided by the manufacturer to charge the Battery provided.
3. Keep both Battery and Charger away from children.
4. Keep the Battery & Charger dry and clean; do not use near oven; do not heat up Battery and always keep Battery and Charger away from water.
5. Do not attempt to disassemble the Battery or Charger.
6. Always turn off the power switch when appliance is not in use.

7. Remove Battery from appliance when not in use for a long period of time.
8. Always store Battery in a cool dry area away from direct sunlight.
9. To maintain optimum Battery performance, always fully discharge and recharge the Battery at least once every 3 months.
10. In order to maintain optimum Battery performance, it is recommended not to leave the Battery completely discharged for more than six (6) months.

Important Charging Notes

1. The Battery Pack may only charge to approximately 80% of its maximum capacity with its first few charge cycles. However, after the first few full charged / discharged cycles, the Battery will charge to full capacity.
2. A substantial drop in operating time per charge may indicate the Battery is near the end of its useful life and should be replaced.
3. For longer periods of inactivity (1 month or more), it is best to run the Battery down until it is fully discharged before storing the Battery Pack. After long periods of storage, the capacity at first recharge will be lower. Normal capacity will be restored in two or three charges and discharge cycles. Remember to also unplug the Charger unit during storage period.
4. The Charger unit was designed to charge the Battery in 4-6 hours only when the Battery temperature is between 40° F (4° C) and 94° F (35° C).
5. If the Battery does not charge properly:
 - a. Check for voltage at outlet by plugging in another standard electrical device and verifying the outlet is active.
 - b. Verify that the outlet is not connected to a light switch that is in the "off" position.
 - c. Check Battery Pack terminals for dirt or debris. Clean off the terminals with cotton swabs and alcohol if necessary.
6. If the Battery does not reach its fully charged state (green LED illuminated on Charger) replace Battery.

Note: Use of Chargers or Battery Packs not sold by Jarden Consumer Solutions will void the warranty.

Charging a Hot Battery Pack

When using the appliance continuously, the batteries in the Battery Pack may become hot. A hot Battery Pack should be allowed to cool down for approximately 30 minutes before attempting to recharge. When the Battery Pack becomes discharged and is hot, this will cause the red LED to blink rapidly. After 30 minutes, reinsert the Battery Pack in the Charger.

Disposing of Battery

Do not attempt to disassemble the Battery or remove any component projecting from the Battery terminals. Fire or injury may result. Protect any exposed terminals with heavy insulating tape prior to disposal.

Nickel-Cadmium Batteries

If unit is equipped with a nickel-cadmium (Ni-Cd) Battery, the Battery must be recycled or disposed of in an environmentally sound manner. The EPA certified RBRC Battery Recycling Seal on the nickel-cadmium (Ni-Cd) Battery indicates Jarden Consumer Solutions is participating in a voluntary program to collect and recycle these batteries at the end of their useful life, applicable only when taken out of service in the United States or Canada. The RBRC program provides a convenient alternative



to placing used Ni-Cd batteries into the trash or the municipal waste stream, which may be illegal in your area.

Please call 1-800-8-Battery for information on Ni-Cd Battery recycling and disposal bans/restrictions in your area, or return your batteries to Jarden Consumer Solutions (JCS) recycling center. JCS involvement in this program is part of our commitment to preserving our environment and conserving our natural resources.

Nickel-Metal Hydride Batteries

If unit is equipped with a nickel-metal hydride (Ni-Mh) Battery, the Battery can be disposed of in a municipal solid waste system.



MAKING FROZEN DRINKS

1. Place the unit on a clean dry flat surface.
2. Ensure the charged Battery is fully inserted into back of unit. The Battery latch will snap into place.
3. Install the Ice Reservoir to the unit by first placing the Ice Reservoir (without the lid) on top of the unit and lock into position by turning counter-clockwise.

NOTE: IN ORDER TO PROPERLY INSTALL THE ICE RESERVOIR TO THE UNIT, MAKE SURE TO FIRST REMOVE THE ICE RESERVOIR LID FROM THE ICE RESERVOIR.

4. Fill the Ice Reservoir with ice cubes.

NOTE: NEVER PUT ANYTHING BUT ICE IN THE ICE RESERVOIR.

5. Place the Ice Reservoir Lid and rotate counterclockwise to the locked position.
6. Lift and remove the Blending Jar. The Ice Chute is spring-loaded and can be pushed up.

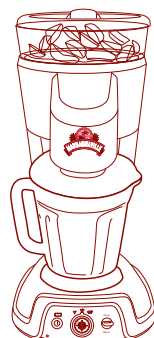
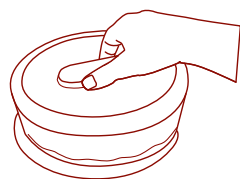
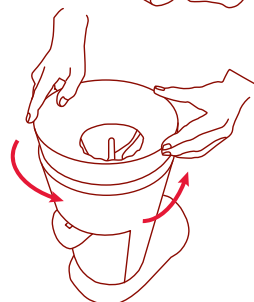
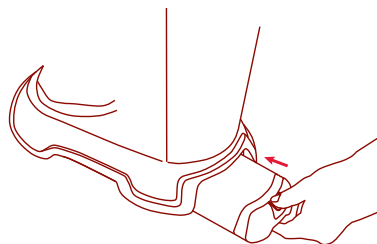

7. Remove Blending Jar Lid.
8. Add appropriate amount of liquid ingredients to the Blending Jar for the number of drinks being made (1, 2 or 3).

For best results, use ice that has been out of the freezer between 10 to 15 minutes

The Best Margarita Recipe – “Ritas”

Ingredients	Amount 12 oz drink (355 mL)					
	1 Drink		2 Drinks		3 Drinks	
	fl oz	ml	fl oz	ml	fl oz	ml
Margaritaville® Gold Tequila	1 1/3	40	2 2/3	80	4	120
Triple Sec	1/3	10	2/3	20	1	30
Lime Juice	2/3	20	1 1/3	40	2	60
Orange Juice	2/3	20	1 1/3	40	2	60
Margaritaville® Margarita Mix	1 1/3	40	2 2/3	80	4	120

9. Replace Blending Jar Lid and return Blending Jar to Blending Base by pushing up on the Ice Chute with the Blending Jar and then placing it on the Blending Base.

NOTE: NEVER SHAKE OR REMOVE JAR DURING OPERATION - BLADE ASSEMBLY WILL GET DAMAGED.



10. Set the Number of Drinks Rotary Switch to correspond to the number of drinks being made

11. Push the ON/OFF button to turn the unit on (power indicator light will blink slowly).

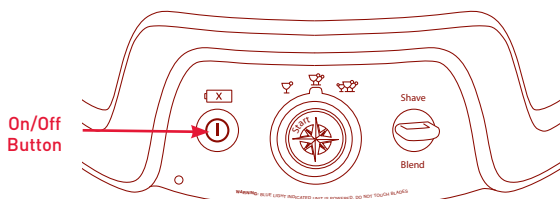

Automatic Shave 'n Blend™ Cycle

12. Start the automatic Shave 'n Blend™ cycle by pushing the Shave 'n Blend™ start button.

NOTE: IF THE BATTERY INDICATOR LIGHT ILLUMINATES – BATTERY NEEDS TO BE RECHARGED.

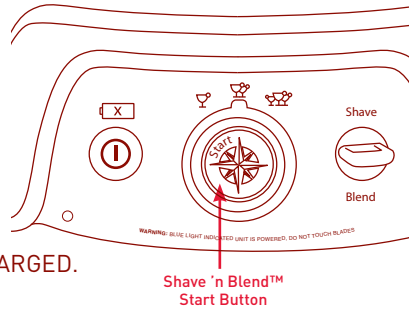

13. The unit will shave ice for the appropriate time and the blender will start automatically. The unit will automatically stop at the completion of the cycle.

CAUTION: DO NOT REMOVE THE JAR FROM THE BLENDER BASE UNTIL THE BLUE LED ON THE SHAVE'N BLEND™ START BUTTON IS SOLID.

NOTE: DURING THE SHAVE AND BLEND CYCLE THE COMPASS INDICATOR LIGHT WILL PULSE BLUE TO INDICATE THE CYCLE PROGRESS.

14. The Compass Indicator Light will return to solid blue to indicate the unit is ready to make more drinks.



NOTE: AFTER 5 MINUTES OF INACTIVITY, THE MACHINE WILL POWER OFF TO CONSERVE BATTERY LIFE.

15. To serve:
- Lift and remove the Blending Jar.
 - Remove Blending Jar Lid.
 - Pour and enjoy.

NOTE: To remove excess ice from the Ice Reservoir hold the Manual Shave Toggle Switch in the up position until the Ice Reservoir is empty.

WARNING: NEVER PLACE FINGERS IN THE ICE HOPPER. THE SHAVING BLADE IS SHARP AND COULD CAUSE INJURY.

16. Turn off the unit.
17. Periodically check the Ice Melt Reservoir and empty as needed.



Manual Cycle

To make a thicker drink:

- a. Hold the Manual “Shave ’n Blend™” Toggle Switch in the up (Shave) position to add more ice to the Blending Jar.
- b. To stop adding ice, release the toggle switch.
- c. To mix the newly added ice into the drink, hold the Manual Blend/Shave Toggle Switch in the down (Blend) position until the desired consistency is achieved. To stop the blending, release the Toggle Switch.
- d. An alternate method to make a thicker drink is to use less drink mix than in the recipe.
Ex. use 12 oz. (355 mL) or less liquid ingredients.

To make a thinner drink:

- a. Hold the Manual Blend/Shave Toggle Switch in the down (Blend) position until the desired consistency is achieved.
- b. To stop blending release the Toggle Switch.
- c. An alternate method to make a thinner drink is to add more drink mix than in the recipe.
Use 14 oz. (414 mL) or more of total mix.

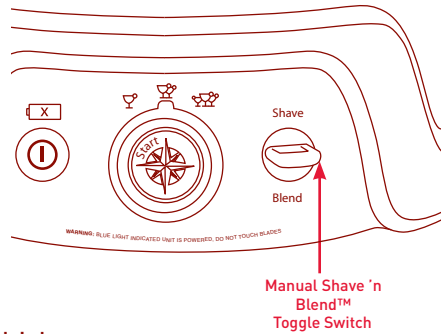

CLEANING AND MAINTENANCE

IMPORTANT: Your Blending Jar, Shaving and Blending Blades are subject to wear during normal use. Always inspect for nicks, chips, or cracks. Always inspect for broken, cracked, or loose blades. If the Jar or Shaving and Blending Blades are damaged, do not use. Call our toll-free customer service number, 1-877-689-2737, to obtain replacement parts.

1. Make sure Battery is removed. Place on a clean dry surface. Turn the unit so the back is facing you. Remove the Ice Reservoir Lid by turning clockwise to the unlock position (Figure 1).
2. To remove the Ice Reservoir, grasp the reservoir with your hand, turn clockwise, and lift to remove (Figure 2).

Note the location of the Shaving Blade inside the Ice Hopper (Figure 2).

WARNING: DO NOT PLACE FINGERS INSIDE THE ICE HOPPER NEAR THE SHAVING BLADE. BLADE IS SHARP HANDLE CAREFULLY.

NOTE: TO REASSEMBLE, INSTALL ICE RESERVOIR TO THE UNIT FIRST, THEN ATTACH ICE RESERVOIR LID.

3. To Remove the Shaving Paddle, press the button located underneath the Ice Chute. If the button cannot be pressed, rotate the Shaving Paddle for a half turn and retry (Figure 3).

While pressing the button, rotate the Shaving Paddle counter-clockwise (to the left) by placing fingers in the ridges of the Shaving Paddle and unscrew. This will expose the Ice Hopper and Shaving Blade.

To re-assemble the Shaving Paddle, simply replace it into the threaded insert and rotate clockwise. Hand tighten only (Figure 4).

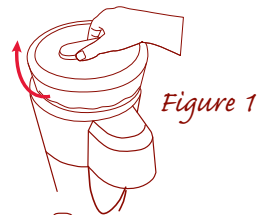

Figure 1

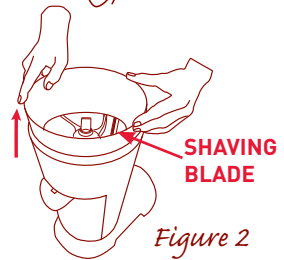

Figure 2

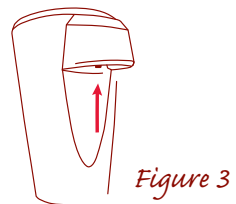

Figure 3

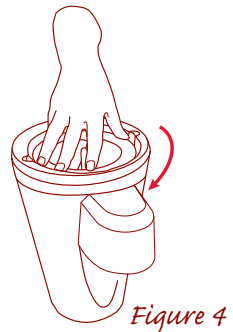
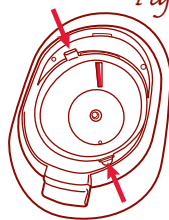

Figure 4

4. Press the two Ice Hopper release catches and lift the Ice Hopper to remove (Figure 5).

Figure 5



PLEASE FOLLOW THE INSTRUCTIONS BELOW TO SAFELY REMOVE THE SHAVING BLADE ASSEMBLY FROM THE ICE HOPPER.

5. Unscrew plastic ring counter clockwise (to the left) in front of shaving blade and remove, then remove the Shaving Blade and store in a safe place. (Figure 6).

Figure 6

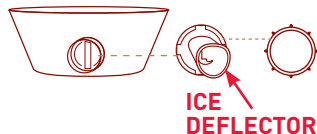

BE SURE TO RINSE THE SHAVING BLADE AND DRY THOROUGHLY BEFORE STORING.

6. Carefully lift the Blending Jar straight up to remove. The Ice Chute is spring-loaded and can be pushed up. If the Blending Jar is not easily removed, rock gently and lift. Do not twist.
7. Turn the Blending Jar upside down and unscrew the Jar Base. Carefully remove the Blending Blade, and Blending Blade Sealing Ring.

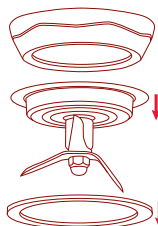

WARNING: THE BLENDING BLADE IS SHARP. HANDLE WITH CARE.

8. To remove the Ice Melt Reservoir hold the unit still and pull straight out on the handle.
9. Blending Jar Lid, Blending Jar, Blending Blade, Blending Blade Sealing Ring and Jar Base can be safely washed in the top rack of your dishwasher. Use only top rack. Failure to do so will result in damage. The Ice Reservoir Lid, Ice Reservoir, Shaving Paddle, Ice Hopper, Ice Deflector Blade Assembly, Shaving Blade and Ice Melt Reservoir are only exposed to ice and water and they should be rinsed with soap and warm water and allowed to air dry.

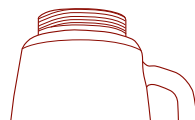

10. Use a damp cloth to clean the outside of the unit.

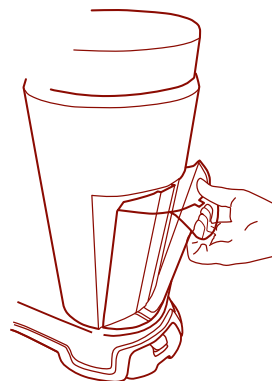

WARNING: REMOVE BATTERY BEFORE CLEANING. DO NOT USE SOLVENTS. NEVER IMMERSE THE UNIT IN WATER.

Troubleshooting for the Cordless Frozen Concoction Maker®

If the Power Indicator Light does not light on Frozen Concoction Maker®: Check that the Battery unit is fully charged and fully inserted into the unit. See page 7.

If liquid leaks from the base of the Blending Jar:

Remove it from the unit and check that the Blending Blade Sealing Ring is properly installed and that the Blending Jar Base is tightened.

If water leaks from the unit: Empty the Ice Melt Reservoir.

If the Blending Jar overflows during the Shave 'n Blend™ cycle:

Follow the drink recipes included in "making frozen drinks" section and make sure to not exceed the specified total volume.

If the Blending Jar will not sit on the Blending Base:

Remove it from the unit and check for ice on the Blending Base.

WARNING: Remove Battery before removing ice from the Blending Base.

If the unit is in fault mode (fast blinking red status Compass Indicator Light):

Check that the Ice Reservoir and Ice Reservoir Lid are properly installed and in the locked position.

If the drink is too watery: Make sure to follow the recipe guide (pg.8) or manually shave more ice until the desired consistency is achieved.

The blades may get jammed and automatically stop when blending heavy/hard objects. Do not blend heavy recipes with this product.

Troubleshooting For Battery & Charger

If the Red LED on the Charger flashes rapidly, make sure the Battery is properly cooled down - see Charging Hot Battery Pack on page 6.

If the Red LED does not pulse, check to see that the Battery is fully seated into the Charger.

Dos and Don'ts

DO NOT place fingers into the Blending Jar or Ice Hopper. The blades in this unit are sharp and could cause injury.

DO NOT place Blending Jar onto Blending Base while motor is running. The spinning Blending Base could damage the Blending Jar.

DO NOT twist Blending Jar when removing. Simply lift and remove. Twisting the Blending Jar could loosen the Blending Jar Base causing it to leak.

DO NOT put hot liquid into the Blending Jar. Hot liquids could be ejected during the blending process causing injury.

DO NOT place ice, frozen foods or very cold liquids into a Blending Jar which has come directly from a hot dishwasher. The sudden change in temperature could cause the Blending Jar to crack.

DO NOT place very hot liquids or foods into a Blending Jar that has come directly from the freezer. The sudden change in temperature could cause the Blending Jar to crack.

DO NOT operate Charger with damaged cord or plug - have them replaced immediately.

DO NOT operate Charger if it has received a sharp blow, been dropped, or otherwise damaged in any way.

DO NOT disassemble Charger. Incorrect reassembly may result in a risk of electric shock, electrocution or fire.

DO follow the cleaning and maintenance instructions prior to your first use and after subsequent uses.

DO remove Battery when putting product in storage.

Disconnect the Charger from the outlet before attempting any cleaning. This will reduce the risk of electric shock. Removing the Battery Pack will not reduce this risk.

1 Year Limited Warranty

Sunbeam Products, Inc. doing business as Jarden Consumer Solutions or if in Canada, Sunbeam Corporation (Canada) Limited doing business as Jarden Consumer Solutions (collectively "JCS") warrants that for a period of one year from the date of purchase, this product will be free from defects in material and workmanship. JCS, at its option, will repair or replace this product or any component of the product found to be defective during the warranty period. Replacement will be made with a new or remanufactured product or component. If the product is no longer available, replacement may be made with a similar product of equal or greater value. This is your exclusive warranty. Do NOT attempt to repair or adjust any electrical or mechanical functions on this product. Doing so will void this warranty.

This warranty is valid for the original retail purchaser from the date of initial retail purchase and is not transferable. Keep the original sales receipt. Proof of purchase is required to obtain warranty performance. JCS dealers, service centers, or retail stores selling JCS products do not have the right to alter, modify or any way change the terms and conditions of this warranty.

This warranty does not cover normal wear of parts or damage resulting from any of the following: negligent use or misuse of the product, use on improper voltage or current, use contrary to the operating instructions, disassembly, repair or alteration by anyone other than JCS or an authorized JCS service center. Further, the warranty does not cover: Acts of God, such as fire, flood, hurricanes and tornadoes.

Use of any battery/battery unit/battery pack/charger not provided, sold and/or manufactured by or for Jarden Consumer Solutions may damage the terminal and/or the battery/battery unit/battery pack/charger and will void the warranty.

Overcharging the battery/battery unit/battery pack may cause damage to the battery/battery unit/battery pack and will void the warranty.

Use of any attachment not recommended, provided, sold and/or manufactured by or for Jarden Consumer Solutions may result in improper operation or damage to the unit and will void the warranty.

What are the limits on JCS's Liability?

JCS shall not be liable for any incidental or consequential damages caused by the breach of any express, implied or statutory warranty or condition.

Except to the extent prohibited by applicable law, any implied warranty or condition of merchantability or fitness for a particular purpose is limited in duration to the duration of the above warranty.

JCS disclaims all other warranties, conditions or representations, express, implied, statutory or otherwise.

JCS shall not be liable for any damages of any kind resulting from the purchase, use or misuse of, or inability to use the product including incidental, special, consequential or similar damages or loss of profits, or for any breach of contract, fundamental or otherwise, or for any claim brought against purchaser by any other party.

Some provinces, states or jurisdictions do not allow the exclusion or limitation of incidental or consequential damages or limitations on how long an implied warranty lasts, so the above limitations or exclusion may not apply to you.

This warranty gives you specific legal rights, and you may also have other rights that vary from province to province, state to state or jurisdiction to jurisdiction.

How to Obtain Warranty Service

In the U.S.A.

If you have any question regarding this warranty or would like to obtain warranty service, please call 1 877-689-2737 and a convenient service center address will be provided to you.

In the U.S.A., this warranty is offered by Sunbeam Products, Inc. doing business Jarden Consumer Solutions located in Boca Raton, Florida 33431. In Canada, this warranty is offered by Sunbeam Corporation (Canada) Limited doing business as Jarden Consumer Solutions, located at 20 B Hereford Street, Brampton, Ontario L6Y 0M1. If you have any other problem or claim in connection with this product, please write our Consumer Service Department. **PLEASE DO NOT RETURN THIS PRODUCT TO ANY OF THESE ADDRESSES OR TO THE PLACE OF PURCHASE.**

NOTES

NOTES



DO NOT RETURN THIS PRODUCT TO THE PLACE OF PURCHASE

For product questions:

Jarden Consumer Services U.S.A.
1-877-689-2737

www.margaritavillecargo.com

©2009 Sunbeam Products, Inc., doing business as Jarden Consumer Solutions.
All rights reserved. Distributed by Sunbeam Products, Inc., doing business as
Jarden Consumer Solutions, Boca Raton, Florida 33431

Margaritaville® is a registered trademark of Margaritaville®.

Printed in China

P. N. 130627-001